

# A5 CABIN PARTS

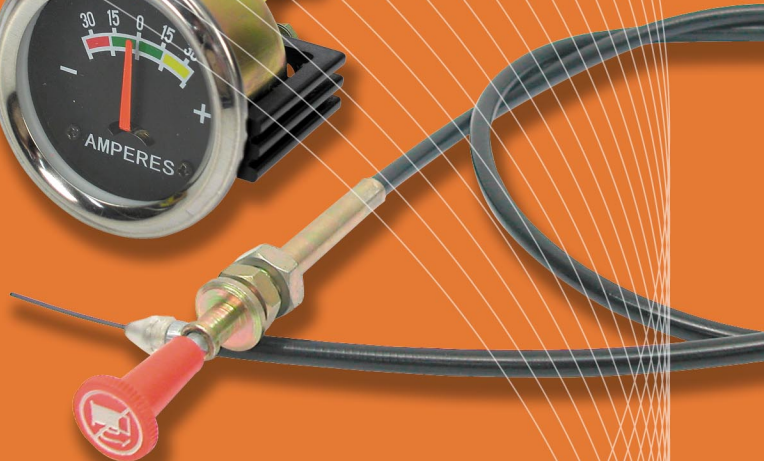

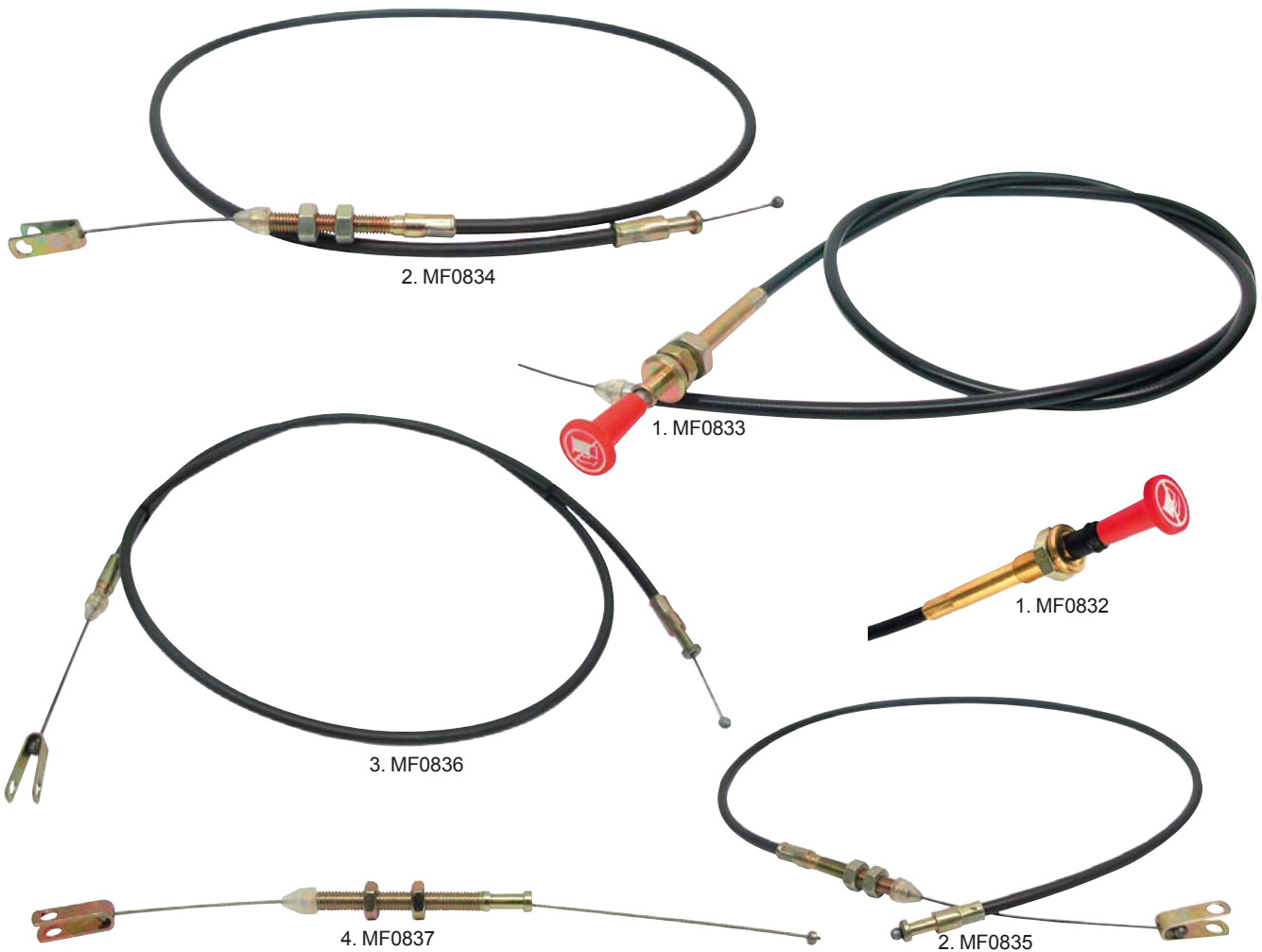

TRACTOR MODEL	1. PULL TO STOP CABLE	2. FOOT THROTTLE CABLE	3. HAND THROTTLE CABLE	4. CABLE FOR FEED PUMP
MF 230, 235, 240, 350, 355, PERKINS AD3.152, AT3.152	<b>MF0832</b> 3597064M92 3701712M91	<b>MF0834</b> 1696815M94 3759026M91		
MF 340, 342, PERKINS AD3.152	<b>MF0833</b> 3597065M92 3701714M91	<b>MF0834 (a)</b> 1696815M94 3759026M91		
MF 365, 375, 390, 390T, 398, 399 PERKINS A4.236, AT4.236, A4.248, A6.354, 6.60	<b>MF0833</b> 3597065M92 3701714M91	<b>MF0835 (a)</b> 3759024M91	<b>MF0836 (a)</b> 3759023M91	<b>MF0837</b> 1696819M93

a - check the measure, cable ends are the same  
 total length      **MF0834** = 1,2 m    **MF0835** = 1,0 m    **MF0836** = 1,35 m

26.10.2007



VPM6005



MF0692



MF0146

TRACTOR MODEL		ENGINE OIL PRESSURE SWITCH	THERMOMETER SENSOR	GEARBOX SAFETY SWITCH
FE35, MF35, MF65, MF 765, MF 135, MF 148, MF 165, MF 168, MF 175, MF 178, MF 185, MF 188				<b>MF0146</b> 1679223M1 1679223M2
MF 230			<b>MF0692</b> 1877731M92	<b>MF0146</b> 1679223M2
MF 235, MF 245			<b>MF0692</b> 1877731M92	
MF 240, MF 250, MF 265, MF 275, MF 283, MF 290, MF 298		<b>VPM6005</b> 3599307M91	<b>MF0692</b> 1877731M92	<b>MF0146</b> 1679223M2
MF 285	<b>A4.248</b>	<b>VPM6005</b> 3599307M91	<b>MF0692</b> 1877731M92	
MF 350, MF 355, MF 360		<b>VPM6005</b> 3599307M91	<b>MF0692</b> 1877731M92	<b>MF0146 (b, j)</b> 1679223M2
MF 365, MF 375 MF 390, MF 390T, MF 398		<b>VPM6005</b> 3599307M91	<b>MF0692</b> 1877731M92	<b>MF0146 (b, j)</b> 1679223M2
MF 399	<b>A6.354.4</b>	<b>VPM6005</b> 3599307M91	<b>MF0692</b> 1877731M92	<b>MF0146 (b, j)</b> 1679223M2
MF 399	<b>6.60</b>	<b>VPM6005</b> 3599307M91	<b>MF0692</b> 1877731M92	<b>MF0146 (b, j)</b> 1679223M2
MF 550, MF 565, MF 575, MF 590		<b>VPM6005</b> 3599307M91	<b>MF0692</b> 1877731M92	<b>MF0146 (b)</b> 1679223M2

b - 3/4" UNF thread

j - →A52208

26.10.2007



## ENGINE OIL PRESSURE SWITCH

### VPM6005

3599307M91

- MF 592, MF 595, 598, 670, 675, 690, 698, 698T, 699, 2620, 2625, 2640, 2645, 2675, 2680, 2685, 2705, 2720, 2725, 2745, 2775, 2805, 3050, 3060, 3065, 3070, 3080, 3085, 3090, 3095, 3115, 3120, 3125, 3505, 3525, 3545, 3610, 3630, 3645, 3650, 3655, 4225, 4235, 4245, 4255, 4260, 4265, 4270, 6110, 6120, 6130, 6140, 6150, 6170, 6180, 6190, 8110, 8120, 8130

## THERMOMETER SENSOR

### MF0692

1877731M92

- MF 592, MF 595, 598, 670, 675, 690, 698, 698T, 699, 2620, 2625, 2640, 2645, 2675, 2680, 2685, 2705, 2720, 2725, 2745, 2775, 2805, 3050, 3060, 3065, 3070, 3080, 3085, 3090, 3095, 3115, 3120, 3125, 3505, 3525, 3545, 3610, 3630, 3645, 3650, 3655, 4225, 4235, 4245, 4255, 4260, 4265, 4270, 6110, 6120, 6130, 6140, 6150, 6170, 6180, 6190, 8110, 8120, 8130

15.06.2007



TRACTOR MODEL	FUEL METER	FUEL SENDER UNIT	TEMP. METER	OIL PRESSURE METER	AMMETER
FE 20, 35, MF 35, 65, 765			V200 (a) 881396M91	V201 (b) 1853097M91	V360 827055M1
MF 135, 148	V8290 898418M1	V8289 897403M91	V200 (a) 881396M91	V201 (b) 1853097M91	V360 827055M1
MF 165, 168, 175, 178, 185, 188	V8290 898418M1	V8291 897389M91	V200 (a) 881396M91	V201 (b) 1853097M91	V360 827055M1
MF 240	MF0091 1877717M93		MF0090 1877719M93		
MF 265, 275, 290	MF0091 1877717M93	MF0232 3762581M1	MF0090 1877719M93		
MF 565	MF0091 1877717M93	MF0092 1613684M92	MF0090 1877719M93		
MF 575, 590, 595	MF0091 1877717M93	MF0093 1613002M3	MF0090 1877719M93		
MF 675, 690, 698, 698T, 699		MF0323 1678518M2			

a - V200 the length of capillary pipe appr. 1800 mm, thread 5/8 UNF  
 b - V201 mechanical oil pressure meter (pipe not included)



## AMMETER

### V361

- universal model
- diameter 52 mm
- in a self-service package



## OIL PRESSURE METER

### V202

- original model
- fits: TE20, TEA20, TED20, TEF20

02.03.2007



PART	FE 35 23 C	MF 35 A3, 152	MF 65 MF 765	MF 135 6-gear	MF 135, MF 148 8-gear	MF 135, MF 148 Multipower	MF 165, 168, 175, 178, 185, 188 6-gear	MF 165, 168, 175, 178, 185, 188 8-gear	MF 165, 168, 175, 178, 185, 188 Multipower
1. Tractor hour meter	<b>V8293K</b> 1850092M93	<b>V8293K3A</b> 890223M92	<b>V8295K (a)</b> 828032M92 <b>V8296K (b)</b> 894432M91			<b>V8298K</b> 899657M92	<b>V8299K</b> 899421M91	<b>MF0677</b> 908473M1	<b>V8300K</b> 89963M91
2. Cable for tractor hour meter	<b>V8318</b> 1876289M93	<b>V8314</b> 1699381M92	<b>V8314</b> 1699381M92	<b>V8316</b> 890232M91	<b>V8316</b> 890232M91	<b>V8316</b> 890232M91	<b>V8318</b> 1876289M93	<b>V8318</b> 1876289M93	<b>V8318</b> 1876289M93
3. Angle transmission	<b>V8294</b> 829489M91						<b>V8292</b> 1853144M1	<b>V8292</b> 1853144M1	<b>V8292</b> 1853144M1
4. Seal for tractor hour meter		<b>V1195</b> 636762M1	<b>V1195</b> 636762M1	<b>V1195</b> 636762M1	<b>V1195</b> 636762M1	<b>V1195</b> 636762M1			

PART	MF 240	MF 265 MF 275 MF 285 MF 298 MF 290	MF 565 MF 575 MF 590	MF 595	MF 675 MF 690 MF 698 MF 699 MF 698T	MF 1080	MF 2620, 2640, 2680, 2720, 2625, 2645, 2725, 3505, 3525, 3545
1. Tractor hour meter		<b>V8301</b> 1674637M92	<b>V8301</b> 1674637M92	<b>V8301</b> 1674637M92	<b>MF0674</b> 3305407M92		
2. Cable for tractor hour meter	<b>V8314</b> 1699381M92	<b>V8318</b> 1876289M93	<b>V8318</b> 1876289M93		<b>MF0679</b> 3302472M91	<b>V8318</b> 1876289M93	<b>VPM5214</b> 3039521M91
3. Angle transmission		<b>V8292</b> 1853144M1	<b>V8292</b> 1853144M1	<b>V8292</b> 1853144M1	<b>V8292</b> 1853144M1	<b>V8292</b> 1853144M1	
4. Seal for tractor meter	<b>V1195</b> 636762M1						

a - up to serial number 571856, indicator rotates counterclockwise  
 b - from serial number 571857, indicator rotates clockwise



## HEADLIGHT

### ST0099

- FE35, MF35, 65, 765
- metal cover
- suitable bulb **P12620/P13620**



## HEADLIGHT H4

### ST0117

- FE35, MF35, 65, 765
- plastic cover
- suitable H4-bulb **P12342/P13342**



## HEADLIGHT H4

### ST0100

- diameter 149 mm
- suitable bulb **P12342/P13342**



## HEAD LAMP

- complete headlight and cover set fits MF 135, 148, 165, 168, 175, 178, 185, 188
- head lamp also fits MF 240, 265, 275, 565, 575, 590, 675, 690, 698, 699

### Left complete

#### V8985

- left head lamp **V8985L** 1672769M91
- left cover **V8985C** 1860184M1
- fixing kit **MF0660** 3405152M91
- bulb connector **ST0165** 3405150M91

### Right complete

#### V8986

- right head lamp **V8986L** 1672768M91
- right cover **V8986C** 1860183M1
- fixing kit **MF0660** 3405152M91
- bulb connector **ST0165** 3405150M91

## HEAD LAMP

### MF0814

1693944M93

- 365, 375, 390, 398, 399, 3060, 3065, 3070, 3080, 3085, 3090, 3095, 3115, 3125, 3610, 3630, 3645, 3650, 3655, 3670, 3680, 3690

## HEAD LAMP

### MF0944

3809346M91

- 4215, 4220, 4225, 4235, 4240, 4245, 4255, 4260, 4265, 4270, 6235, 6245, 6255, 6260, 6265, 6270, 6280, 6290, 8210, 8220, 8240, 8250, 8260

08.01.2007

## LIGHT SWITCH

### T0241

1668816M2  
- 100-, 200-, 500- and 600-series

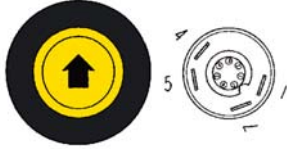

## LIGHT SWITCH

### ST050023

881670M1  
- FE35, MF35, 65, 765

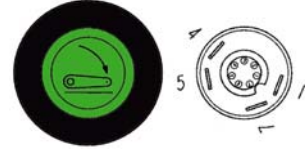

## PUSH KNOB SWITCH UP/DOWN

### ST7047

3388402M1  
- 4 poles  
- 300, 2200, 3600, 1007, 3115, 3120, 3125 series

## PUSH KNOB SWITCH HYDR. UP

### ST7037

3714137M1  
- 4 poles  
- 6100, 6200, 8100, 8200 series

## PUSH KNOB SWITCH HYDR. DOWN

### ST7038

3714138M1  
- 4 poles  
- 6100, 6200, 8100, 8200 series

## COMBI SWITCHES

### MF1100

3809592M92  
- 4215, 4220, 4225, 4235, 4240, 4245, 4250, 4255, 4260, 4265, 4270



## COMBI SWITCHES

### MF1101

3713669M2  
- 6110, 6120, 6130, 6140, 6150, 6160, 6170, 8170, 8180, 8210, 8220, 8240, 8250, 8260, 8270, 8280



26.10.2007



ST118201110



ST0134A



ST34273126



ST34273127

## TRIANGLE FOR SLOW VEHICLES

- material weatherproof SAN/ABS-plastic
- daylight reflector, dark reflector with prism
- fasteners according to SFS 5093/SAE J725D
- compulsory in Finland for example on tractors, tractor trailers, farming-, earth moving and working machines

**Plastic**  
**ST118201110**

**Fastener to triangle**  
**ST34273126**

**Sheet metal**  
**ST0134A**

**Link for vehicle**  
**ST34273127**



## VERTICAL REFLECTOR

- 180 x 40 mm
- holes for mounting screws 2 pcs Ø 6 mm, distance of screws 150 mm
- MF 135, 148, 165, 168, 175, 188 years 1964-1976

**White**  
**ST100476**

**Red**  
**ST100475**



## ROUND REFLECTOR

- overall diameter 84 mm, reflective surface Ø 77 mm
- base plate made of ABS-plastic
- in the middle of base plate M5 mounting screw with nuts and spring washers

**White**  
**ST100471**

**Yellow**  
**ST100472**

**Red**  
**ST100470**



## SIDE LIGHT/REAR LIGHT

**MF0663**

- MF35, 135, 135, 178 years 1956-1971
- spare lens red **MF0664**
- spare lens white **MF0665**, thickness 12 mm, Ø 56 mm
- rubber gasket **MF0666**

## SIDE LIGHT

**MF0667**

- 880399M2
- MF 135, 148, 165, 168, 175, 178, 188 years 1964-1971



## SIDE LIGHT

**MF0668**

- 1678580M91
- MF 240, 265, 275, 565, 575, 590, 595 years 1977-1987

## SIDE LIGHT

**ST342101031**

- MF 265 palmu years 1977-1987
- spare lens **ST342127031**



## LENS FOR SIDE LIGHT

**T3581**

- 1424346M1
- MF 300, 3000-series years 1987-1995

## SIDE LIGHT

- MF 675, 690, 698, 698T, 699 years 1982-1987

**Left**  
**T3041**

- spare lens **T3042**

**Right**  
**T3040**

- spare lens **T3043**





## LENS FOR REAR LIGHT

### MF0230

54587713

- MF 135, 148, 165, 168, 175, 178, 188 years 1964-1976
- fits to the original light



## COMPLETE REAR LIGHT

### MF0234

- MF 135, 148, 165, 168, 175, 178, 188 years 1964-1976

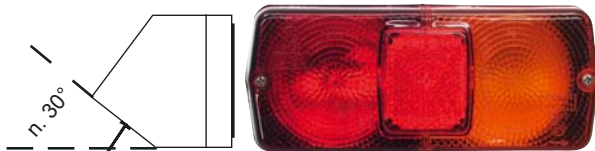

## REAR LIGHT

- MF240, 265, 275 years 1980-1987
- spare lens **F0526** (3310307M91)

### Left

**MF0661**

1678868M92

### Right

**MF0662**

1678869M92

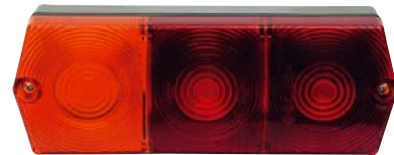

## REAR LIGHT

### ST342102001

- MF 265 palmu years 1977-1987
- spare lens **ST342128001**

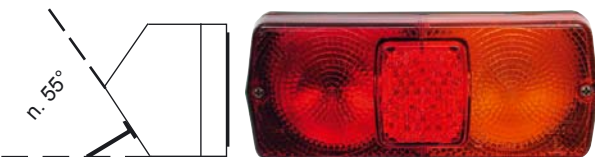

## REAR LIGHT

- MF 565, 575, 590, 595
- spare lens **F0526** (3310307M91)

### Left

**MF0322**

### Right

**MF0342**



## REAR LIGHT

### F0525

- MF 300 years 1987-1994
- spare lens **F0526** (3310307M91)



## REAR LIGHT

### MF0763

3536200M91

- MF 300, 3000-series years 1987-1995
- spare lens **MF0764**
- suitable bulbs 1 x **P12498** 21 W BAI5S (blink) and 1 x **P12499** 21/5 W BAY150 (rear light/break light)

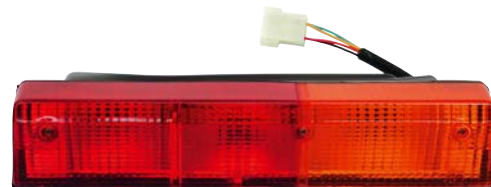

## REAR LIGHT

- MF 675, 690, 698, 698T, 699 years 1982-1987

### Left

**T3046**

- spare lens **T3044**

### Right

**T3047**

- spare lens **T3045**

17.08.2007



## FRONT MASK

### VPM1016

1687817M91

- 265, 275, 290, 298, 675, 690, 698

## SIGN FOR MASK



### VPM1015

1682944M91

- 230, 240, 250, 260, 265, 285, 290, 298, 698, 698T, 699



## GRILLS

### MF0990

9524

- TE20, TEA20, TED20



## FRONT T-PANEL



### MF0991

9533

- TE20, TEA20, TED20

## FENDER

### MF0157

1883356M92

- TEA20, TED20, TEF20  
(skin only)



## REAR FENDER

- TEA20, TED20, TEF20,  
FE35, MF35, MF35X, MF135,  
MF148, MF230, MF240, MF250, MF253

**Left** (on picture)

### MF0810

1884287M97

**Right**

### MF0811

1884286M97



## FENDER

- MF 3000 series

**Left**

### MF1055

3581656M1

**Right** (on picture)

### MF1054

3581655M1



## FRONT EMBLEM

### MF1104

1860156M1

- MF135, MF148, MF165, MF168,  
MF175, MF178, MF185, MF188



## FRONT EMBLEM

### MF1103

828136M1

- MF35

02.03.2007

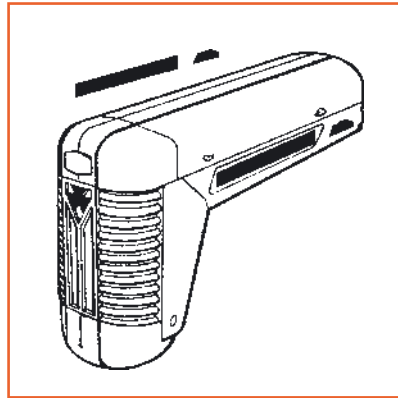
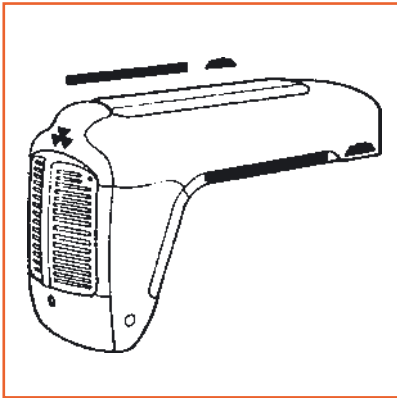

TRACTOR MODEL	ORDER NUMBER
MF 35	<b>V6750</b> 3406970M91
MF 35X	<b>V6751</b> 3406971M91
MF 65	V6752
MF 135	V6753



TRACTOR MODEL	ORDER NUMBER
MF 148	V6753
MF 165, 168	V6754
MF 175, 178	V6754
MF 185, 188	V6754

TRACTOR MODEL	ORDER NUMBER
MF 265	MF0604
MF 275	MF0605
MF 565	MF0606
MF 690	MF0609

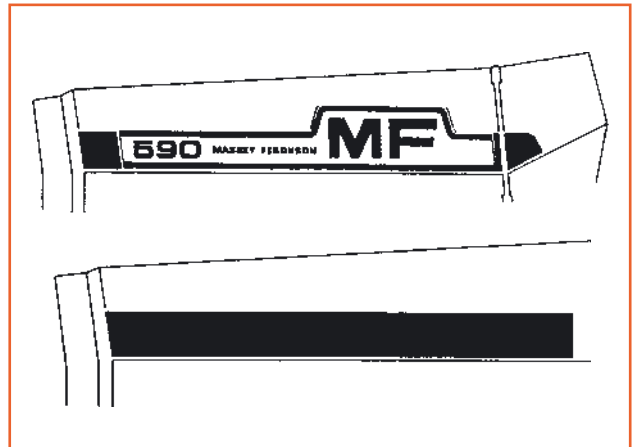

MF0084



MF0085



V6825A



V6825

TRACTOR MODEL	SIDE SIGN BASE	STICKER FOR SIDE SIGN	BONNET CATCH	BATTERY CASE CATCH
MF 135, 148	<b>MF0083</b> (complete) 1865460M1		<b>V6825A</b> 885365M91	<b>V6825</b> 897788M91
MF 165	<b>MF0084</b> 1866944M1	<b>MF0085</b> 1866946M1	<b>V6825A</b> 885365M91	<b>V6825</b> 897788M91
MF 168	<b>MF0084</b> 1866944M1		<b>V6825A</b> 885365M91	<b>V6825</b> 897788M91
MF 175, 178, 185	<b>MF0084</b> 1866944M1		<b>V6825A</b> 885365M91	<b>V6825</b> 897788M91
MF 188	<b>MF0084</b> 1866944M1		<b>V6825A</b> 885365M91	<b>V6825</b> 897788M91

26.10.2007



## DOOR HANDLE

- universal type

**Outer**

**T0139**

1884003M91

**Inner**

**T0140**



## DOOR LOCK

**T0138**

- universal type



## OUTER HANDLE WITH LOCK

**VLD1426**

1897727M91

- 200-series



## DOOR LOCK

- Palmu-cabin

**Left**

**T0312**

**Right**

**T0313**

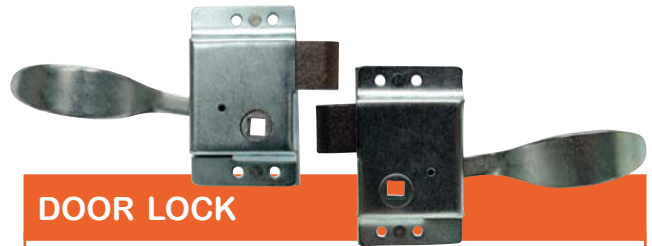

## DOOR LOCK

**Left**

**VLD1449**

**Right**

**VLD1448**



VLD1407

## OUTER HANDLE WITH LOCK

**VLD1417**

3476151M1

- 300-series

**Lock left**

**VLD1407**

3476171M1

**Lock right**

**VLD1406**

3476157M1



VLD1413

MF0133

MF0233

## DOOR LOCK AND HANDLE

**VLD1413**

1667203M92

- 500-series

**Left**

**MF0133**

1670819M92

**Right**

**MF0233**

1670820M92



MF0883

## DOOR LOCK AND HANDLE

- 600-series

**Handle inner**

**MF0880**

3301856M2

**Handle outer**

**MF0883**

3301853M91

**Lock left**

**MF0881**

3301854M1



## DOOR LOCK AND HANDLE

**MF0884**

3385311M91

- left

- 3000-series



## COMPLETE MIRROR

**V3980**  
1871948M93  
- 500-series



## MIRROR

**T1527**  
3902430M1  
- 3000-series



## CABIN FAN

**MF0231**  
1680361M91  
- 500-series



## HEATER FAN MOTOR

**T3565**  
3310831M91  
- 600 and 3000-series  
- resistor **T3565A** (3304510M92)



## HEATER FAN MOTOR

**F0177**  
- 300-series, on dashboard



## HEATER FAN MOTOR

**ST0145**  
- universal type "Smith"



## WIPER BLADE MOTOR

<b>T0128</b> - universal type - arm <b>T0129</b> - blade <b>T0130</b> (1897910M1)	<b>T0131</b> - universal type, 12V/110° - arm <b>T0129</b> - blade <b>T0130</b> (1897910M1)
--	--



## HORN

**ST0147**  
794220M1

## TOOL BOX

**T0455**  
825633M91  
- universal model, size 400 x 120 x 130, black



26.10.2007



TRACTOR MODEL	CABIN TYPE	REAR GLASS CYLINDER	SUN ROOF CYLINDER	DOOR CYLINDER
MF 265, 275, 290		<b>MF0135</b> 3301920M92		
MF 350, 355, 360, 365, 375, 390, 390T, 398, 399	Early- and HI-line models	<b>MF0765</b> <b>KS0103</b> 3476187M1	<b>MF0769</b> <b>KS0105</b> 1897726M91	<b>MF0770</b> <b>KS0106</b> 3478919M2
MF 390, 390T, 398, 399	From June -89	<b>MF0765</b> <b>KS0103</b> 3476187M1		<b>MF0770</b> <b>KS0106</b> 3478919M2
MF 550, 560, 565, 575, 590, 595		<b>MF0134</b> (a) <b>KS0101</b> 1873903M93		
MF 675, 690, 698, 698T, 699		<b>MF0135</b> (a) <b>KS0102</b> 3301920M92	<b>MF0769</b> <b>KS0105</b> 1897726M91	
MF 2620, 2640, 2645, 2680, 2685, 2720, 2725		<b>MF0134</b> <b>KS0101</b> 1873903M93	<b>MF0769</b> <b>KS0105</b> 1897726M91	<b>KS0107</b> 1897726M91
MF 3050, 3060, 3065, 3070, 3080, 3090, 3610, 3630, 3650, 3680		<b>MF0767</b> <b>KS104</b> 3389556M1	<b>MF0769</b> <b>KS0105</b> 1897726M91	<b>KS0108</b> 3385316M91
MF 4200, 4300 -sarjat		<b>MF0982</b> 3805354M1	<b>MF0983</b> 3901826M91	<b>MF0982</b> 3805354M1
MF 6100, 6200, 8100, 8200 -sarjat		<b>MF0985</b> 3902140M1	<b>MF0769</b> <b>KS0105</b> 1897726M91	<b>MF0984</b> 3902121M3

a - MF0134 length 475 mm, MF0135 length 525 mm



## 265 - 290 series

265, palmu 19, 275, 290, palmu 22

	MODELS	ORDER NUMBER	WINDOW	DESCRIPT.	ORIGINAL PART NUMBER	SIZE mm (H x W x thickness)	TINT
1	265, palmu 19	MF0803	Rear window			593 x 1029	clear
2	265, palmu 19	MF0804	Rear window			593 x 1130	clear
3	265, palmu 19	MF0805	Rear window			660 x 1038	clear
4	275, 290, palmu 22	MF0806	Rear window	9 holes			clear



## 300 series

350, 355, 360, 365, 375, 390, 398, 399

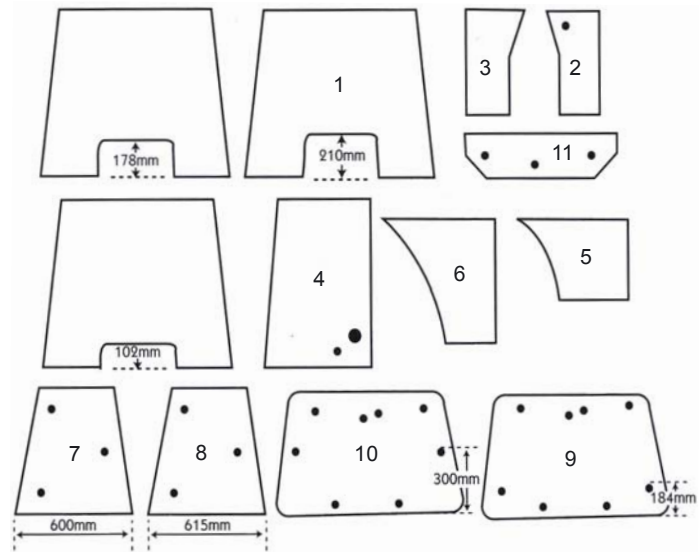

	ORDER NUMBER	WINDOW	DESCRIPTION	ORIGINAL PART NUMBER	SIZE mm (H x W x thickness)	TINT	FIXING
1	MF0954 (a)	Windscreen		3475992M1	1245 x 835 x 5	clear	GR
2	MF0955	Lower front	left, 1 hole	3475994M1	673 x 355 x 5	clear	GR
3	MF0956	Lower front	left & right	3475995M1	673 x 355 x 5	clear	GR
4	MF0957	Upper door	left & right, 2 holes	3476159M1	758 x 610 x 5	clear	GR
5	MF0958 (b)	Lower door	left & right	3476160M1	610 x 400 x 5	clear	GR
6	MF0959 (c)	Lower door	left & right	3477778M1	657 x 610 x 5	clear	GR
7	MF0960 (d)	Side	left & right, 3 holes	3476127M1	600 x 580 x 5	clear	BLT/K
8	MF0961 (e)	Side	left & right, 3 holes	3900618M1	615 x 580 x 5	clear	BLT/K
9	MF0787 (b)	Rear upper	8 holes	3476182M1	1220 x 590 x 6	clear	BLT/K
10	MF0788 (c)	Rear upper	8 holes	3477716M1	1220 x 590 x 6	clear	BLT/K
11	VPM7154	Rear, lower	3 holes	3476137M1	778 x 192 x 5	clear	BLT

a - fits 365, 375, 390, 398, 399

b - the lower hole of the fastening bow 180 mm from the lower edge of the glass

c - the lower hole of the fastening bow 300 mm from the lower edge of the glass

d - up to cabin B18008

e - from cabin B18009

Fixing: B = bonded  
BLT = bolt on  
F = framed  
GR = glazing rubber  
K = knock on rubber



## 500 series

550, 560, 565, 575, 590, 592, 595

	ORDER WINDOW NUMBER	DESCRIPTION	ORIGINAL PART NUMBER	SIZE mm (H x W x thickness)	TINT	FIXING
1	MF0807	Upper, rear	1699450M2	965 x 597 x 5	clear	GR

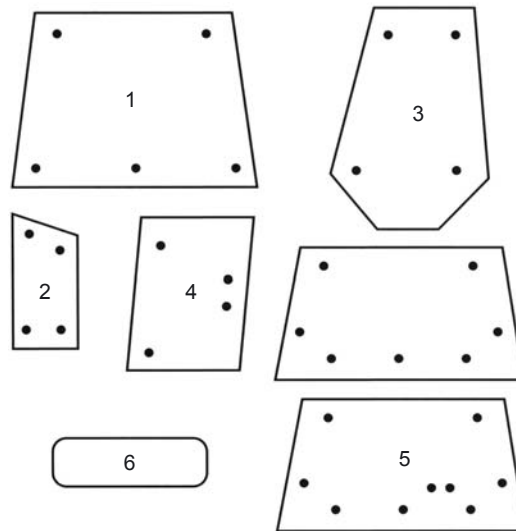

## 600 series

675, 690, 698, 698T, 699

	ORDER WINDOW NUMBER	DESCRIPTION	ORIGINAL PART NUMBER	SIZE mm (H x W x thickness)	TINT	FIXING
1	MF0962	Windscreen	3301875M3	1178 x 824 x 5	tinted	BLT
2	MF0963	Lower front	3301879/80M3	481 x 256 x 5	tinted	BLT
3	MF0964	Door	3301841/45M3	1002 x 713 x 5	tinted	BLT
4	MF0965	Side	3302705/06M3	690 x 525 x 5	tinted	K/BLT
5	MF0747(a)	Upper rear	3306547M2	1210 x 734 x 5	tinted	K/BLT
6	MF0966	Lower rear	3302607M1	584 x 220 x 5	tinted	GR

a - 2 extra holes for wiper blade motor

Fixing: B = bonded GR = glazing rubber  
 BLT = bolt on K = knock on rubber  
 F = framed



## 3000 series

3050, 3060, 3065, 3070, 3075, 3080, 3085, 3090, 3095, 3115,  
3120, 3125, 3610, 3630, 3635, 3645, 3650, 3655, 3670, 3680, 3690

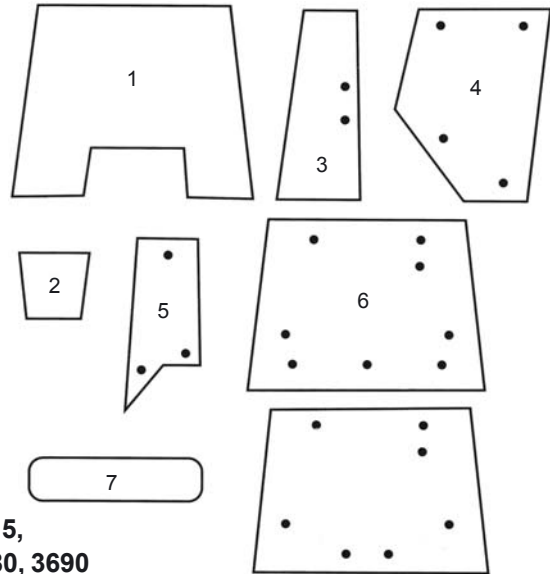

ORDER NUMBER	WINDOW	DESCRIPTION	ORIGINAL PART NUMBER	SIZE mm (H x W x thickness)	TINT	FIXING	
1	MF0967 (a)	Windscreen	3385240M3	1220 x 1120 x 6	tinted	GR	
2	MF0968 (a)	Lower front	left & right	346 x 317 x 6	tinted	GR	
3	MF0969	Door front	left & right, 2 holes	1045 x 304 x 6	tinted	B	
4	MF0970	Door rear	left & right, 4 holes	1045 x 680 x 6	tinted	BLT	
5	MF0971	Side	left & right, 3 holes	890 x 360 x 6	tinted	BLT	
6	MF0786	Upper rear	8 holes	3389902M2	980 x 900 x 6	tinted	F/BLT
7	MF0972	Lower rear	3389389M1	531 x 222 x 6	tinted	GR	

a - up to motor 50129



## 4200 series

4215, 4220, 4225, 4235, 4240, 4245, 4255, 4260, 4265, 4270 (also 4300 series)

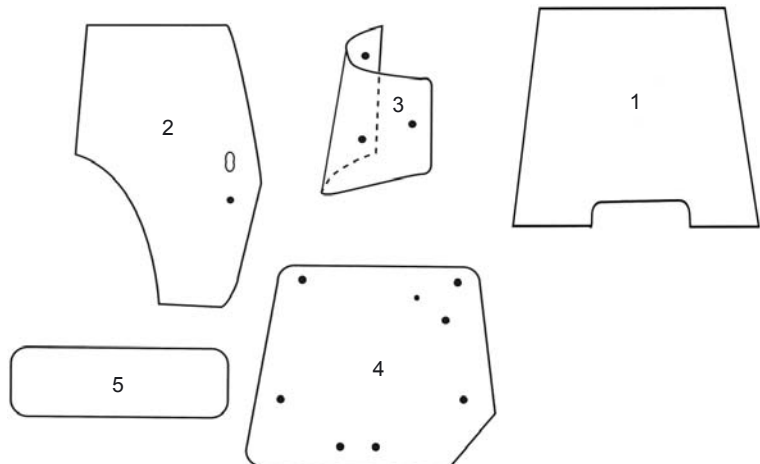

ORDER NUMBER	WINDOW	DESCRIPTION	ORIGINAL PART NUMBER	SIZE mm (H x W x thickness)	TINT	FIXING	
1	MF0973 (a, b)	Windscreen	2 holes	3821747M1	1245 x 908 x 5	tinted	B
2	MF0951 (a)	Door	right, 2 holes	3805642M1	1500 x 930 x 5	tinted	B
2	MF0953 (a)	Door	left, 2 holes	3805643M1	1500 x 930 x 5	tinted	B
3	MF0974 (a)	Rear corner	right, 3 holes	3806590M2	780 x 685 x 5	tinted	BLT
3	MF0975 (a)	Rear corner	left, 3 holes	3806591M2	780 x 685 x 5	tinted	PK
4	MF0952 (a, b)	Upper rear	8 holes	3806581M2	820 x 785 x 5	tinted	K/BLT
5	MF0976	Lower rear	3804726M2	538 x 198 x 5	tinted	B	

a - also fits MF4300-series

b - 2 holes wiper blade motor

Glasses 2, 3, 4 and 5 are curved.

Fixing: B = bonded  
BLT = bolt on

F = framed  
GR = glazing rubber  
K = knock on rubber

08.01.2007

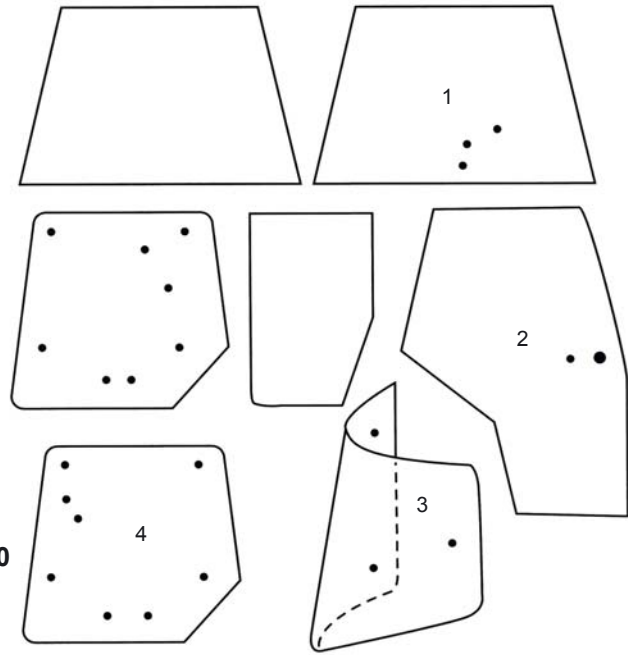

**6100, 6200, 8100, 8200 series**  
**6110, 6120, 6130, 6140, 6150, 6160, 6170, 6180, 6190**  
**6235, 6245, 6255, 6260, 6265, 6270, 6280, 6290**  
**8110, 8120, 8130, 8140, 8150, 8160, 8170, 8180**  
**8210, 8220, 8240, 8250, 8260, 8270, 8280**

ORDER NUMBER	WINDOW	DESCRIPTION	ORIGINAL PART NUMBER	SIZE mm (H x W x thickness)	TINT	FIXING
1	MF0977 (a)	Windscreen	3777602M2	1280 x 903 x 5	tinted	B
2	MF0978	Door	3902123M1	1490 x 1020 x 6	tinted	B
2	MF0979	Door	3902124M1	1490 x 1020 x 6	tinted	B
3	MF0980	Rear corner	3902130M1	860 x 820 x 6	tinted	BLT
3	MF0981	Rear corner	3902131M1	860 x 820 x 6	tinted	BLT
4	MF0870 (a)	Rear window	3715438M1	875 x 865 x 6	tinted	K/BLT

a - 3 holes for wiper blade motor  
 Windows 2 and 3 are curved

Fixing: B = bonded  
 BLT = bolt on  
 F = framed  
 GR = glazing rubber  
 K = knock on rubber



## WINDSCREEN GLUE SET

### HK269

- dispensed cold, non-drip
- max. sticking time 25 min
- ready for driving in 2 hours
- set includes: cleaning agent 20 ml, cleaning linen, primer 10 ml, primer-spreader, glue 310 ml



VLC3223    VLC3225    VLC3227    VLC3228    VLC3231

TRACTOR MODEL	FRONT	REAR	ORDER NUMBER
Massey Ferguson 100-series			<b>VLC3223</b> 3620123M91
200-series (→01260)	X		<b>VLC3223</b> 3620123M91
200-series (01260→)	X		<b>VLC3225</b> 3620125M91
300-series	X		<b>VLC3227</b> 3620127M91
300-series		X	<b>VLC3223</b> 3620123M91
500-series (GB) (France, Lucas)	X		<b>VLC3224</b> 3620124M91
500-series (France, SEV Marchall)	X		<b>VLC3223</b> 3620123M91
600-series	X		<b>VLC3231</b> 3620129M91
600-series		X	<b>VLC3223</b> 3620123M91
2000, 2005-series (20")	X		<b>VLC3227</b> 3620127M91
2000, 2005-series (22")	X		<b>VLC3229</b> 3620128M91
2000, 2005-series		X	<b>VLC3220</b> 3620121M91
3000, 3100, 3600-series	X		<b>VLC3231</b> 3620129M91
3000, 3100, 3600-series		X	<b>VLC3223</b> 3620123M91
MF cabin 30, 32, 34, 38	X		<b>VLC3228</b> 3620127M91

TRACTOR MODEL	FRONT	REAR	ORDER NUMBER
Massey Ferguson industrial MF 14K, 16K		X	<b>VLC3227</b> 3620127M91
MF 20B, 20D, 20E	X		<b>VLC3224</b> 3620124M91
MF 20F	X		<b>VLC3227</b> 3620127M91
MF 24	X		<b>VLC3225</b> 3620125M91
MF 30D, 30H	X		<b>VLC3229</b> 3620128M91
MF 40E	X		<b>VLC3227</b> 3620127M91
MF 40E		X	<b>VLC3223</b> 3620123M91
MF 50	X		<b>VLC3225</b> 3620125M91
MF 50B, 50B II	X		<b>VLC3223</b> 3620123M91
MF50B, 50B II		X	<b>VLC3220</b> 3620121M91
MF 50E, 50EX	X		<b>VLC3227</b> 3620127M91
MF 50E, 50EX	X		<b>VLC3223</b> 3620123M91
MF50D, 50H, 50HX, 60H	X		<b>VLC3227</b> 3620127M91
MF 50H, 50HX, 60H-series	X		<b>VLC3229</b> 3620128M91